

model series: HY-4-7 and HY-6-7

**Super Bright LEDs: RED, GREEN, YELLOW or BLUE - 7 INCH High Digits  
4 and 6 DIGITS**

Metal and Stainless Steel Enclosures  
Black, White, Chrome and Gold colors

## STANDARD FEATURES:

- \* Infra Red hand held REMOTE CONTROL for all functions
- \* 12 or 24 Hour and Military Display Format (user selectable via remote)
- \* Stand - Alone operation for Home or Office
- \* Backup:  
Self-recharging backup - NO BATTERY NEEDED
- \* Day/Date/Month/Year Alternating display selection
- \* Fully Adjustable Brightness (Manual via remote control)
- \* Julian Day display
- \* Auto Leap-Year correction
- \* Day Light Savings correction ( N. America )
- \* Timers:  
Wake-Up Alarm Timer with soft beeper control  
Stop-Watch function up to 1/100 sec resolution  
Up/Down Presettable Timer and Counter with Alarm (up to 99hrs:59min:59sec or 999999 counts)  
Cycling timer, Up and Down
- \* On-Board Alarms: Internal Alarm buzzer
- \* NON-GLARE lens
- \* NON-MULTIPLEXING - Camera friendly
- \* Variety of enclosure colors.



IR Remote Control

## SPECIFICATIONS:

Supply Voltage:	115V or 208-240V, 50/60Hz 24 or 12V AC/DC
Power:	12VA average
Operating Temperature:	0C to +50C (32F to 122F) (military range optional)
Humidity:	95% RH max. non cond.
4-digits model Dimensions:	24.5" x 10" x 3" (62.3cm x 25.4 x 7.6cm)
6-digits model Dimensions:	35.25" x 10" x 3" (89.5cm x 25.4cm x 7.6cm)
Visibility:	Up to 250 Ft. (80m)

## Optional FEATURES:

- \* Direct Replacement for existing MASTER - SLAVE SYSTEM CLOCKS (replaces round, mechanical or electronic)
- \* Multiple Master-Slave correction modes:  
Master-Slave Power Line Carrier sync (Simplex)  
Master-Slave 2 Wire, RS485 Twisted Pair Sync/Communication  
Master-Slave wireless communication on power line wiring  
Master-Slave wireless RF, radio communication  
Master-Slave network ethernet communication  
Master-Slave BCD digital, ASCII Time Code  
RS232, USB and RS485 serial communication ( PC port as the Master )  
Master-Slave 2 and 3 Wire, 24V Minute Impulse Sync
- \* Multi-Zone synchronized Master-Slave system
- \* Temperature Monitoring and Control:  
Multi-Event Programmable Thermostat ( up to 32 events/day )  
Heating - Cooling Auto Change-Over  
Inside and Outside Thermometer function  
Min/Max Temperature Memory  
Temperature Alarm and Relay outputs ( up to 2 x Form C, 10Amp/250V )
- \* Backup:  
10 Year Lithium battery option
- \* Atomic Clock radio option  
( WWVB60, DCF77, HBG75, MSF60, OHTAKADOYA40, HAGANE60 )
- \* Atomic Clock GPS option
- \* Automatic Brightness with Auto-dimming option
- \* Timers:  
Multi-Event Programmable Timer ( up to 32 events/day )  
Stop-Watch function up to 1/100 sec resolution  
External Start/Stop/Reset switch inputs  
Auto-reloading time period measurement  
Continuous time count on power failure
- \* On-Board Alarm Relays for timers and counters:  
( up to 2 x Form C, 10Amp/250V ) For external load, siren or horn.



standard color: black  
custom colors: chrome, gold , stainless steel and other

### 4-digit model

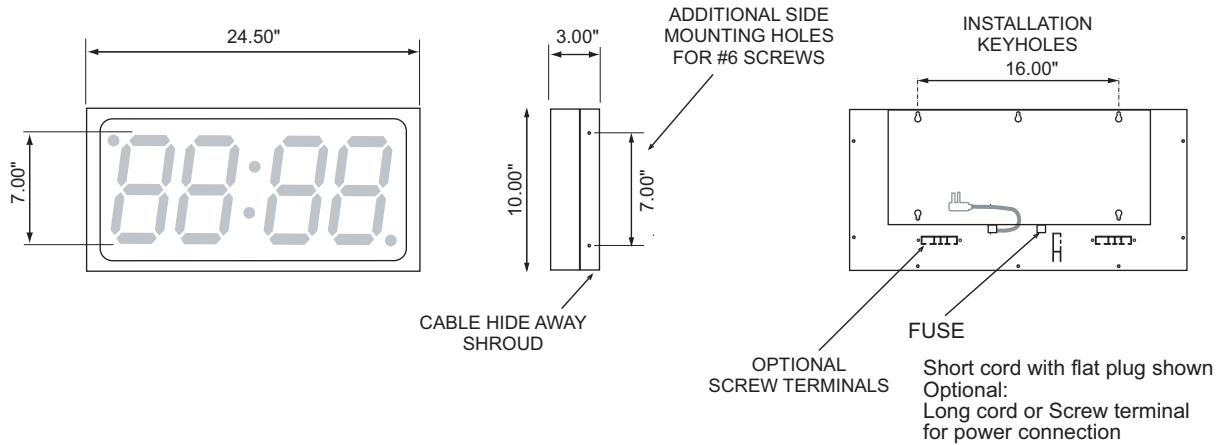

### 6-digit model

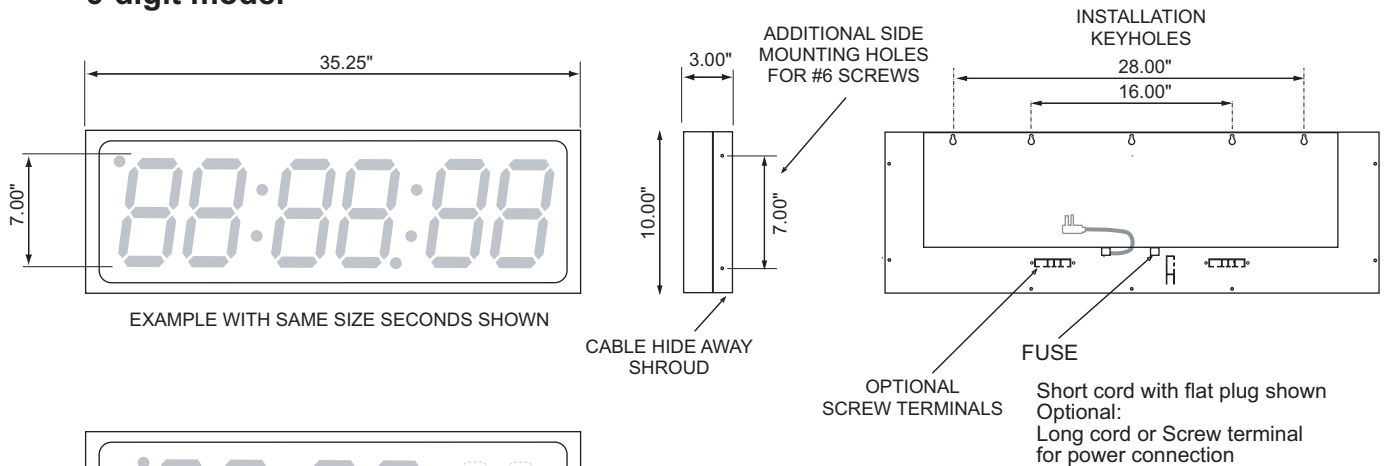

OPTIONAL DOUBLE-SIDED MOUNTING BRACKET (OPTION # BR7X2)

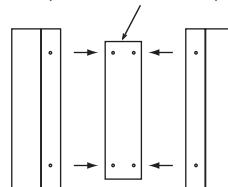

standard color: black  
custom colors: chrome, gold , stainless steel and other

### OPTIONAL FLUSH MOUNT METHODS

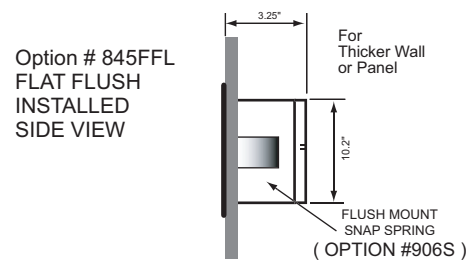
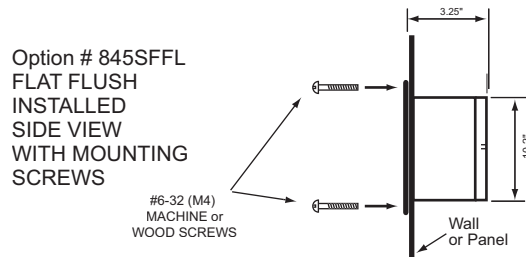

### 4 DIGITS MODEL

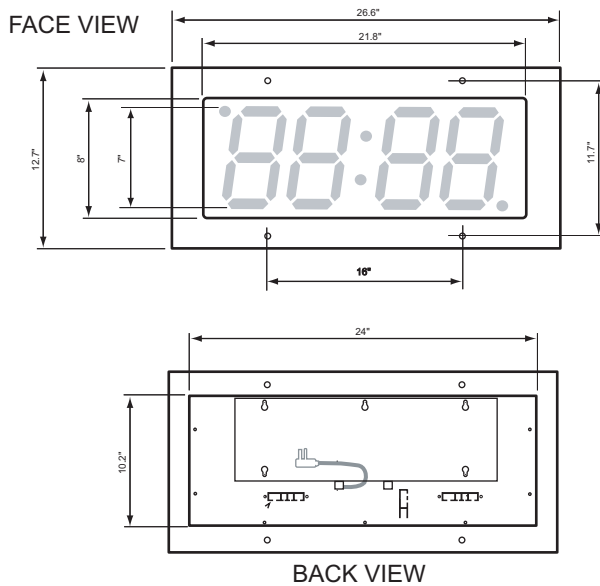

### 6 DIGITS MODEL

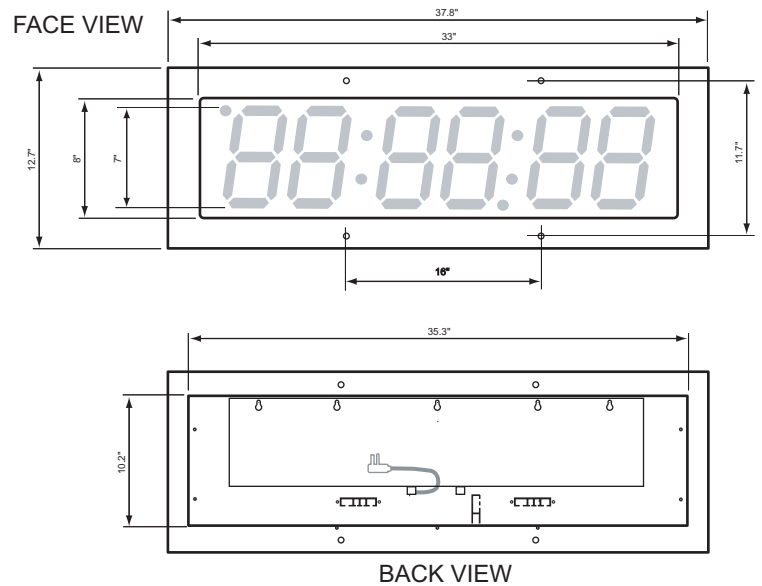

### BACK PANEL SIDE VIEW

ENCLOSURE  
BACK PANEL  
series 732R or 732

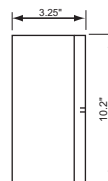

Straight 90 Deg. Back flange  
( also used for back-to-back mounting )

